

- ★ Green Device Available
- ★ Super Low Gate Charge
- ★ Excellent Cdv/dt effect decline
- ★ Advanced high cell density Trench technology

**Product Summary**

BVDSS	RDSON	ID
-20V	75mΩ	-3A

**Description**

The SI2301 is the high cell density trenched N-ch MOSFETs, which provides excellent RDSON and efficiency for most of the small power switching and load switch applications.

The SI2301 meet the RoHS and Green Product requirement with full function reliability approved.

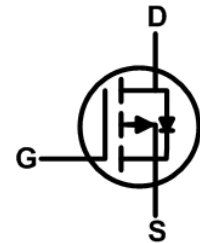
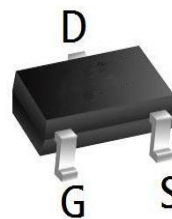
**SOT23 Pin Configuration**

**Absolute Maximum Ratings**

Symbol	Parameter	Rating	Units
$V_{DS}$	Drain-Source Voltage	-20	V
$V_{GS}$	Gate-Source Voltage	$\pm 12$	V
$I_D@T_A=25^\circ C$	Continuous Drain Current, $V_{GS} @ -4.5V^1$	-3	A
$I_D@T_A=70^\circ C$	Continuous Drain Current, $V_{GS} @ -4.5V^1$	-2.2	A
$I_{DM}$	Pulsed Drain Current <sup>2</sup>	-12	A
$P_D@T_A=25^\circ C$	Total Power Dissipation <sup>3</sup>	1	W
$T_{STG}$	Storage Temperature Range	-55 to 150	$^\circ C$
$T_J$	Operating Junction Temperature Range	-55 to 150	$^\circ C$

**Thermal Data**

Symbol	Parameter	Typ.	Max.	Unit
$R_{\theta JA}$	Thermal Resistance Junction-ambient <sup>1</sup>	---	125	$^\circ C/W$
$R_{\theta JC}$	Thermal Resistance Junction-Case <sup>1</sup>	---	---	$^\circ C/W$

**Electrical Characteristics** ( $T_J=25^{\circ}\text{C}$  unless otherwise specified)

Symbol	Parameter	Test Condition	Min.	Typ.	Max.	Units
<b>Off Characteristic</b>						
$V_{(BR)DSS}$	Drain-Source Breakdown Voltage	$V_{GS}=0V, I_D=-250\mu A$	-20	-	-	V
$I_{DSS}$	Zero Gate Voltage Drain Current	$V_{DS}=-20V, V_{GS}=0V,$	-	-	-1	$\mu A$
$I_{GSS}$	Gate to Body Leakage Current	$V_{DS}=0V, V_{GS}=\pm 12V$	-	-	$\pm 100$	nA
<b>On Characteristics</b>						
$V_{GS(th)}$	Gate Threshold Voltage	$V_{DS}=V_{GS}, I_D=-250\mu A$	-0.5	-0.7	-1.0	V
$R_{DS(on)}$	Static Drain-Source on-Resistance <small>note2</small>	$V_{GS}=-4.5V, I_D=-3A$	-	75	97	m $\Omega$
		$V_{GS}=-2.5V, I_D=-2A$	-	95	123	
<b>Dynamic Characteristics</b>						
$C_{iss}$	Input Capacitance	$V_{DS}=-10V, V_{GS}=0V,$ $f=1.0MHz$	-	503	-	pF
$C_{oss}$	Output Capacitance		-	67	-	pF
$C_{rss}$	Reverse Transfer Capacitance		-	58	-	pF
$Q_g$	Total Gate Charge	$V_{DS}=-10V, I_D=-2A,$ $V_{GS}=-4.5V$	-	4.1	-	nC
$Q_{gs}$	Gate-Source Charge		-	0.8	-	nC
$Q_{gd}$	Gate-Drain("Miller") Charge		-	1.1	-	nC
<b>Switching Characteristics</b>						
$t_{d(on)}$	Turn-on Delay Time	$V_{DD}=-10V, I_D=-3A,$ $R_G=1\Omega, V_{GEN}=-4.5V,$ $R_L=1.2\Omega$	-	11	-	ns
$t_r$	Turn-on Rise Time		-	52	-	ns
$t_{d(off)}$	Turn-off Delay Time		-	16	-	ns
$t_f$	Turn-off Fall Time		-	10	-	ns
<b>Drain-Source Diode Characteristics and Maximum Ratings</b>						
$I_S$	Maximum Continuous Drain to Source Diode Forward Current		-	-	-3	A
$I_{SM}$	Maximum Pulsed Drain to Source Diode Forward Current		-	-	-12	A
$V_{SD}$	Drain to Source Diode Forward Voltage	$V_{GS}=0V, I_S=-3A$	-	-	-1.2	V

Notes:1. Repetitive Rating: Pulse Width Limited by Maximum Junction Temperature

 2. Pulse Test: Pulse Width $\leq 300\mu s$ , Duty Cycle $\leq 2\%$

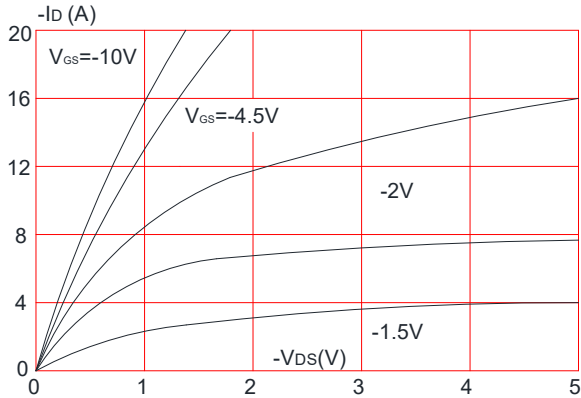
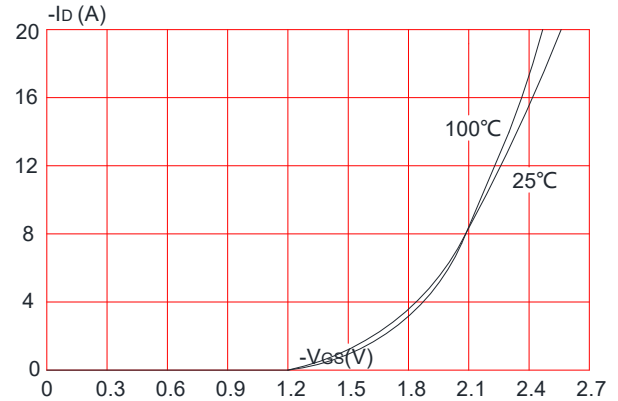
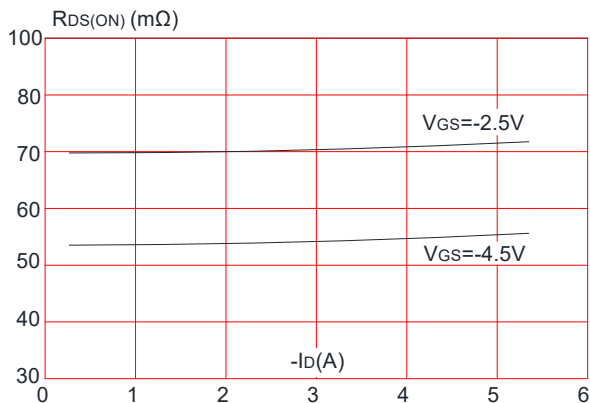
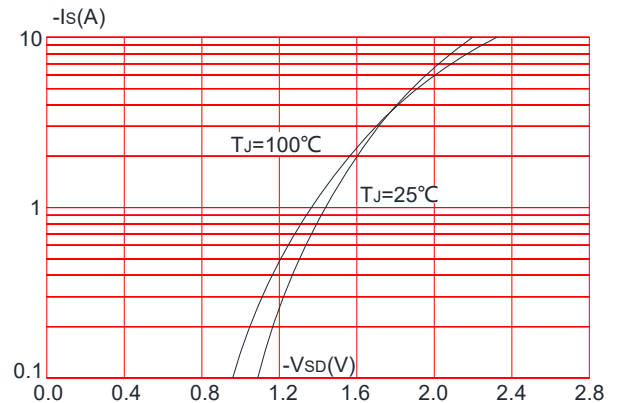
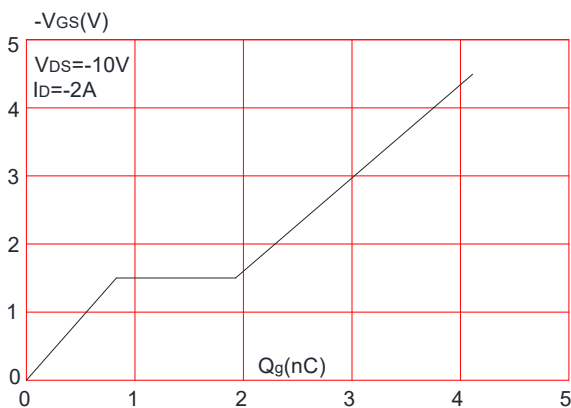
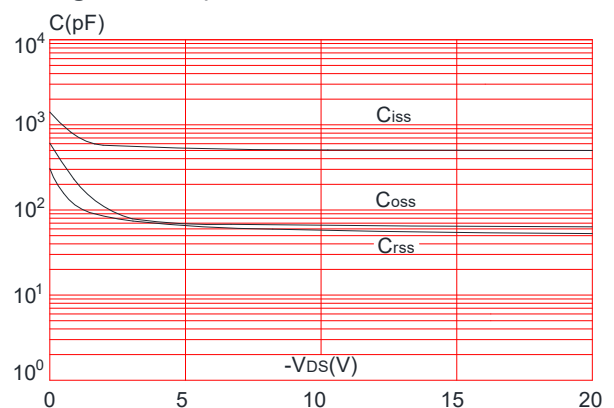
**Typical Performance Characteristics**
**Figure 1: Output Characteristics**

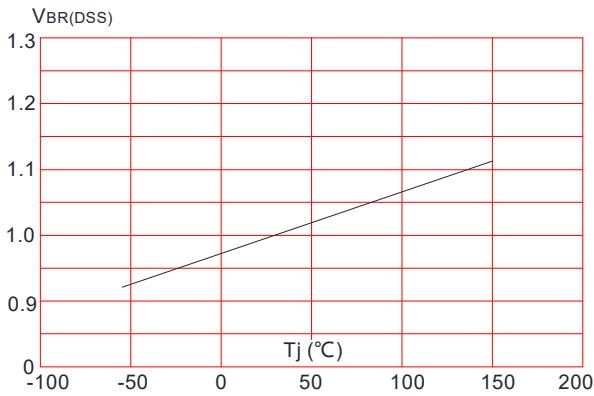
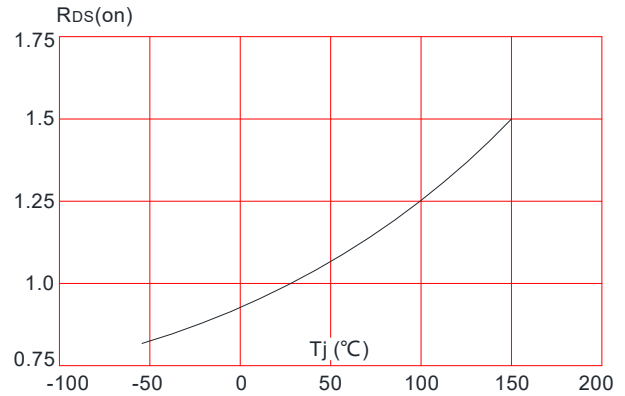
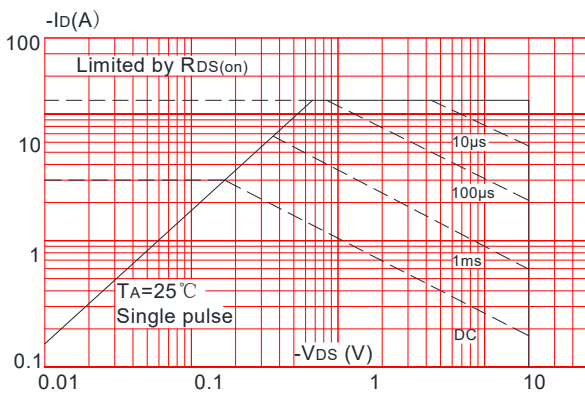
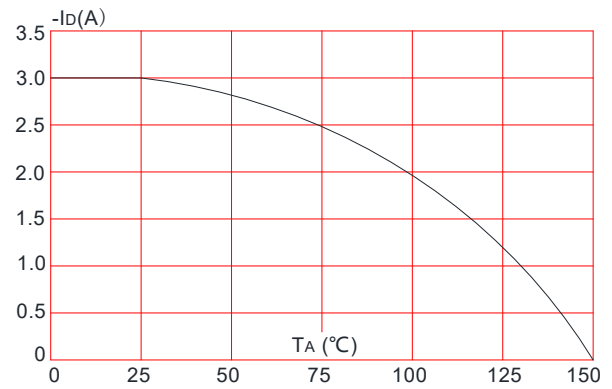
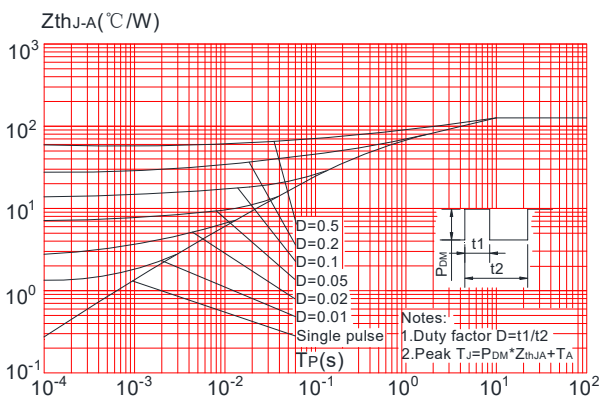
**Figure 2: Typical Transfer Characteristics**

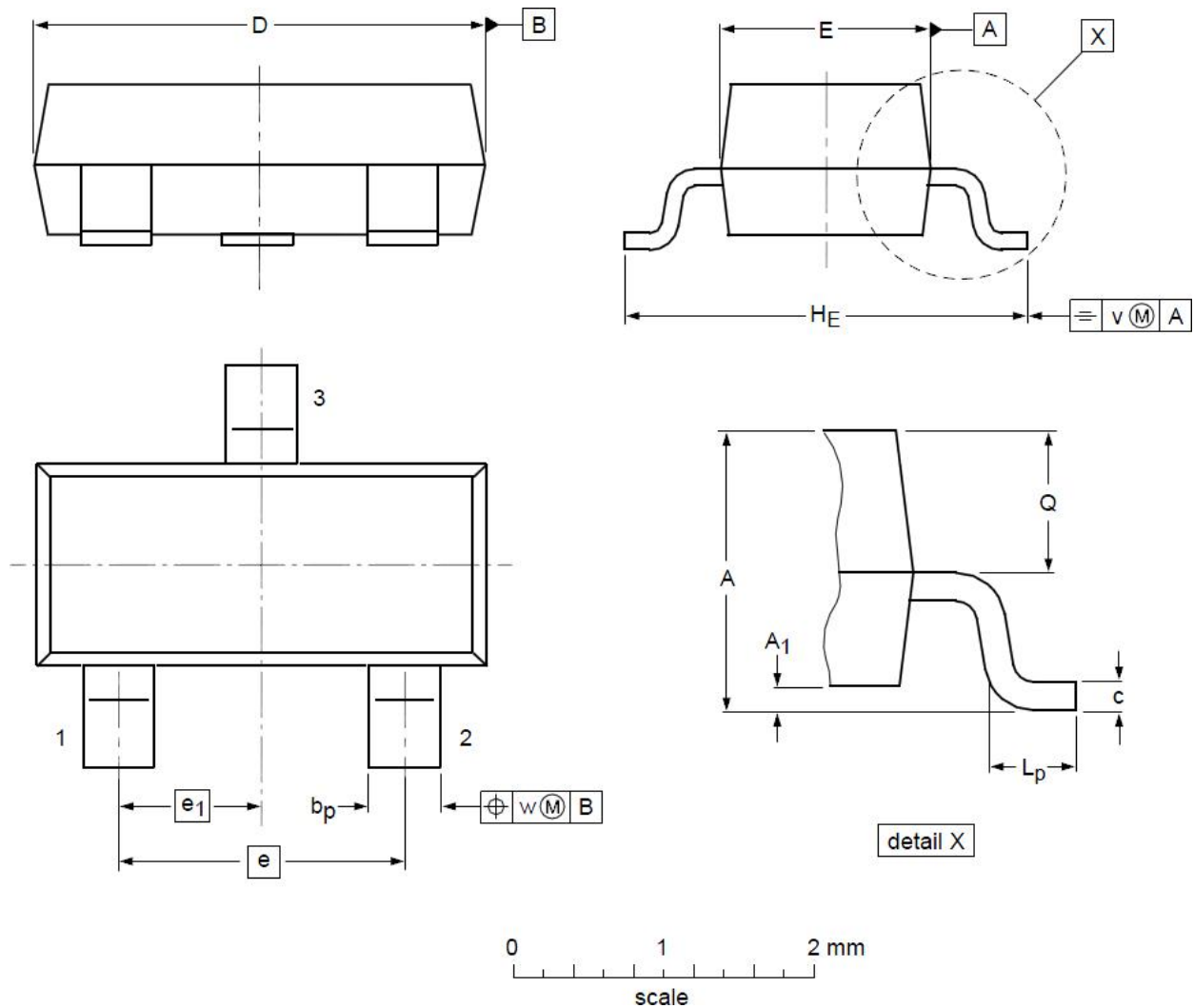
**Figure 3: On-resistance vs. Drain Current**

**Figure 4: Body Diode Characteristics**

**Figure 5: Gate Charge Characteristics**

**Figure 6: Capacitance Characteristics**

**P-Ch 20V Fast Switching MOSFETs**
**Figure 7: Normalized Breakdown Voltage vs. Junction Temperature**

**Figure 8: Normalized on Resistance vs. Junction Temperature**

**Figure 9: Maximum Safe Operating Area**

**Figure 10: Maximum Continuous Drain Current vs. Ambient Temperature**

**Figure.11: Maximum Effective Transient Thermal Impedance, Junction-to-Ambient**

**Package Mechanical Data-SOT-23**

**DIMENSIONS ( unit : mm )**

Symbol	Min	Typ	Max	Symbol	Min	Typ	Max
<b>A</b>	0.90	1.01	1.15	<b>A<sub>1</sub></b>	0.01	0.05	0.10
<b>b<sub>p</sub></b>	0.30	0.42	0.50	<b>c</b>	0.08	0.13	0.15
<b>D</b>	2.80	2.92	3.00	<b>E</b>	1.20	1.33	1.40
<b>e</b>	--	1.90	--	<b>e<sub>1</sub></b>	--	0.95	--
<b>H<sub>E</sub></b>	2.25	2.40	2.55	<b>L<sub>p</sub></b>	0.30	0.42	0.50
<b>Q</b>	0.45	0.49	0.55	<b>v</b>	--	0.20	--
<b>w</b>	--	0.10	--				