



- ★ Green Device Available
- ★ Super Low Gate Charge
- ★ Excellent CdV/dt effect decline
- ★ Advanced high cell density Trench technology

Product Summary

BVDSS	RDSON	ID
-30V	48mΩ	-4.2A

Description

The AO3401 is the high cell density trenched N-ch MOSFETs, which provides excellent RDSON and efficiency for most of the small power switching and load switch applications. The AO3401 meet the RoHS and Green Product requirement with full function reliability approved.

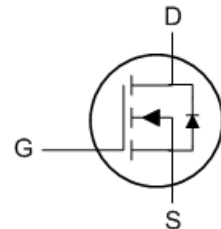
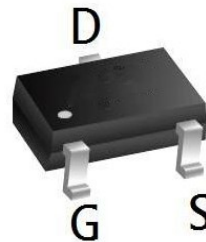
SOT23 Pin Configuration

Absolute Maximum Ratings (@ $T_A = 25^\circ\text{C}$ unless otherwise specified)

Symbol	Parameter	Value	Units
V_{DS}	Drain-to-Source Voltage	-30	V
V_{GS}	Gate-to-Source Voltage	± 12	V
I_D	Continuous Drain Current	$T_A = 25^\circ\text{C}$	-4.2
		$T_A = 100^\circ\text{C}$	-3
I_{DM}	Pulsed Drain Current ⁽¹⁾	-16	A
P_D	Power Dissipation	$T_A = 25^\circ\text{C}$	1.2
$R_{\theta JA}$	Thermal Resistance, Junction to Ambient ⁽²⁾	108	$^\circ\text{C/W}$
T_J, T_{STG}	Junction & Storage Temperature Range	-55 to 150	$^\circ\text{C}$

Electrical Characteristics ($T_J = 25^\circ\text{C}$ unless otherwise specified)

Symbol	Parameter	Conditions	Min.	Typ.	Max.	Unit
Off Characteristics						
$V_{(BR)DSS}$	Drain-Source Breakdown Voltage	$I_D = -250\mu\text{A}, V_{GS} = 0\text{V}$	-30	-	-	V
I_{DSS}	Zero Gate Voltage Drain Current	$V_{DS} = -30\text{V}, V_{GS} = 0\text{V}$	-	-	1.0	μA
I_{GSS}	Gate-Body Leakage Current	$V_{DS} = 0\text{V}, V_{GS} = \pm 12\text{V}$	-	-	± 100	nA
On Characteristics						
$V_{GS(th)}$	Gate Threshold Voltage	$V_{DS} = V_{GS}, I_D = -250\mu\text{A}$	-0.6	-0.95	-1.3	V
$R_{DS(ON)}$	Static Drain-Source ON-Resistance ⁽³⁾	$V_{GS} = -10\text{V}, I_D = -4.2\text{A}$	-	48	62	$\text{m}\Omega$
		$V_{GS} = -4.5\text{V}, I_D = -3\text{A}$	-	56	73	$\text{m}\Omega$
		$V_{GS} = -2.5\text{V}, I_D = -3\text{A}$	-	75	98	$\text{m}\Omega$
Dynamic Characteristics						
C_{iss}	Input Capacitance	$V_{GS} = 0\text{V}, V_{DS} = -15\text{V}, f = 1\text{MHz}$	-	553	-	pF
C_{oss}	Output Capacitance		-	57	-	pF
C_{rss}	Reverse Transfer Capacitance		-	35	-	pF
Q_g	Total Gate Charge	$V_{GS} = 0 \text{ to } -4.5\text{V}$ $V_{DS} = -15\text{V}, I_D = -3\text{A}$	-	6.5	-	nC
Q_{gs}	Gate Source Charge		-	1.4	-	nC
Q_{gd}	Gate Drain("Miller") Charge		-	1.7	-	nC
Switching Characteristics						
$t_{d(on)}$	Turn-On DelayTime	$V_{GS} = -4.5\text{V}, V_{DD} = -15\text{V}$ $I_D = -3\text{A}, R_{GEN} = 3\Omega$	-	10	-	ns
t_r	Turn-On Rise Time		-	86	-	ns
$t_{d(off)}$	Turn-Off DelayTime		-	150	-	ns
t_f	Turn-Off Fall Time		-	357	-	ns
Drain-Source Diode Characteristics and Max Ratings						
I_S	Maximum Continuous Drain to Source Diode Forward Current		-	-	-4	A
I_{SM}	Maximum Pulsed Drain to Source Diode Forward Current		-	-	-16	A
V_{SD}	Drain to Source Diode Forward Voltage	$V_{GS} = 0\text{V}, I_S = -4.2\text{A}$	-	-	-1.2	V
t_{rr}	Body Diode Reverse Recovery Time	$I_F = -3\text{A}, di/dt = 80\text{A}/\mu\text{s}$	-	36	-	ns
Q_{rr}	Body Diode Reverse Recovery Charge		-	5	-	nC

- Notes:
1. Repetitive Rating: Pulse Width Limited by Maximum Junction Temperature.
 2. $R_{\theta JA}$ is measured with the device mounted on a 1inch^2 pad of 2oz copper FR4 PCB
 3. Pulse Test: Pulse Width $\leq 300\mu\text{s}$, Duty Cycle $\leq 0.5\%$.

Typical Performance Characteristics

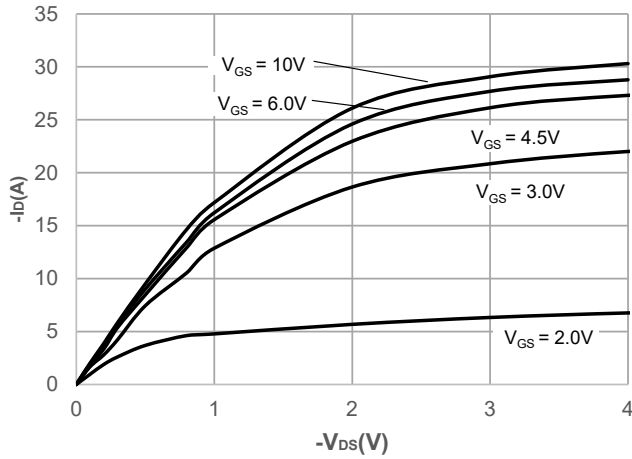
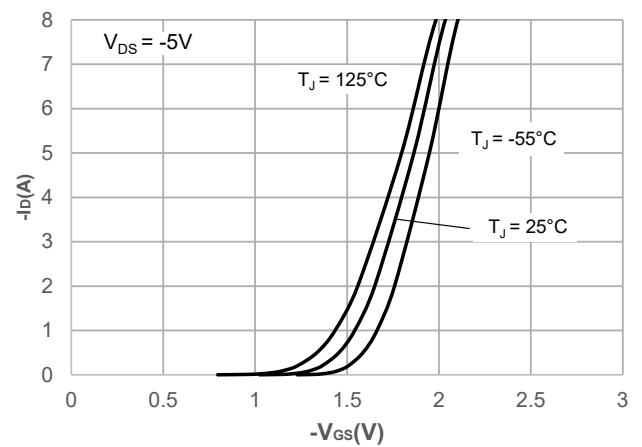
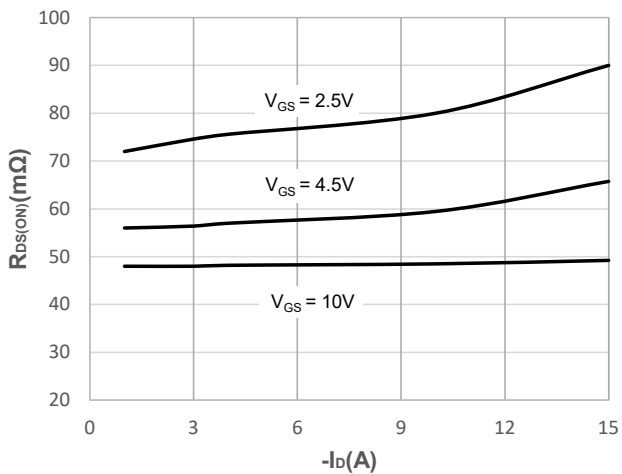
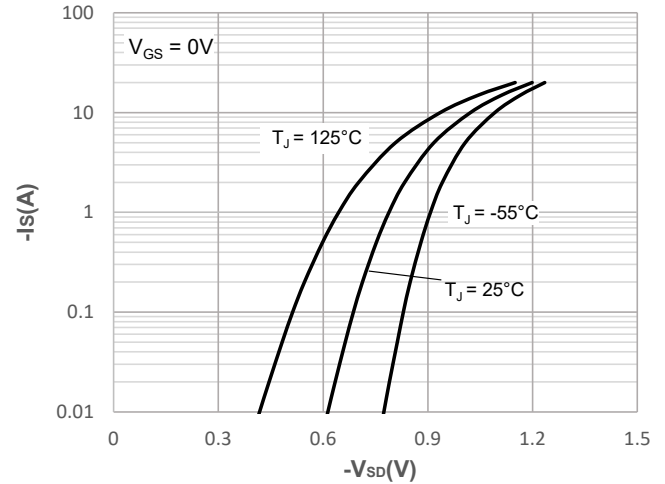
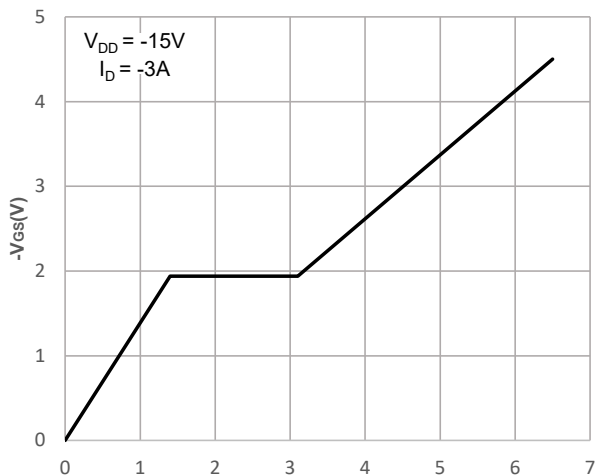
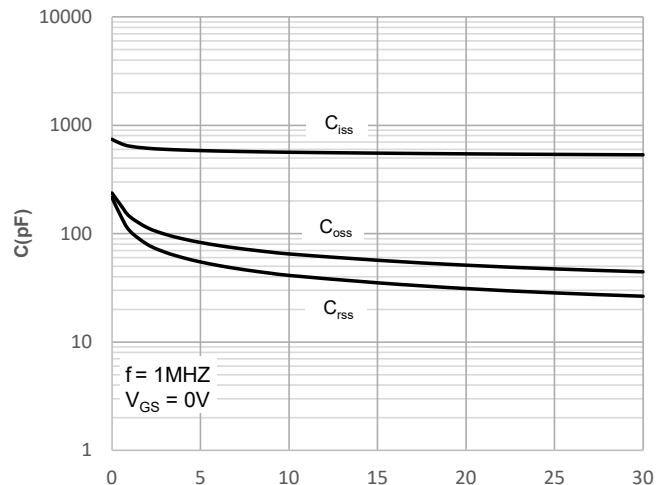
Figure 1: Output Characteristics

Figure 2: Typical Transfer Characteristics

Figure 3: On-resistance vs. Drain Current

Figure 4: Body Diode Characteristics

Figure 5: Gate Charge Characteristics

Figure 6: Capacitance Characteristics

Typical Performance Characteristics

Figure 7: Normalized Breakdown voltage vs. Junction Temperature

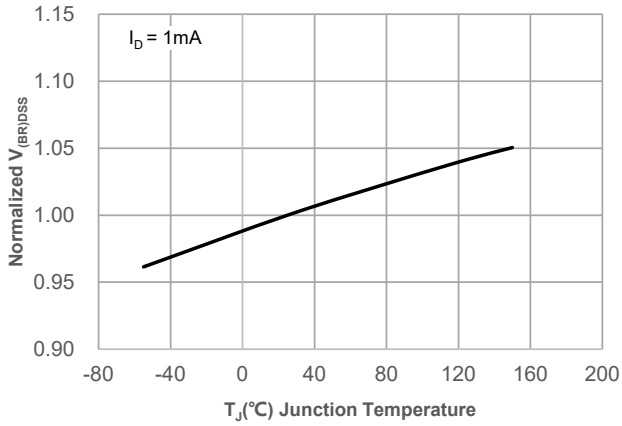

Figure 8: Normalized on Resistance vs. Junction Temperature

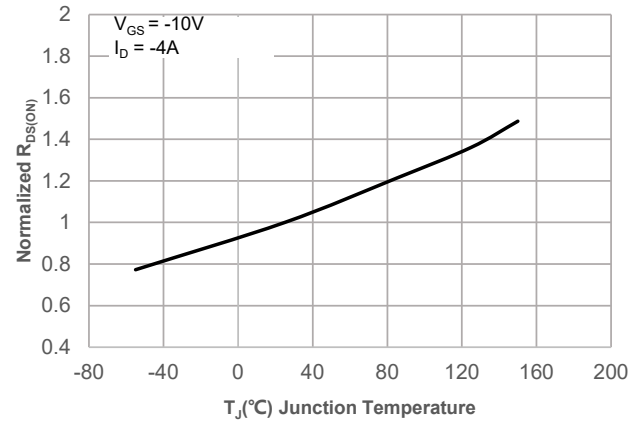

Figure 9: Maximum Safe Operating Area

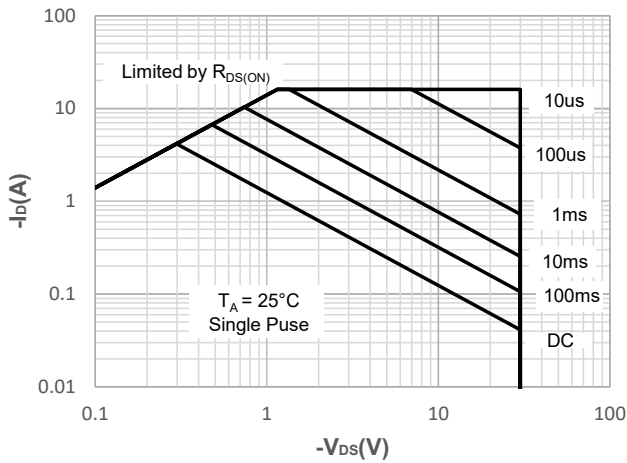

Figure 10: Maximum Continuous Driand Current vs. Ambient Temperature

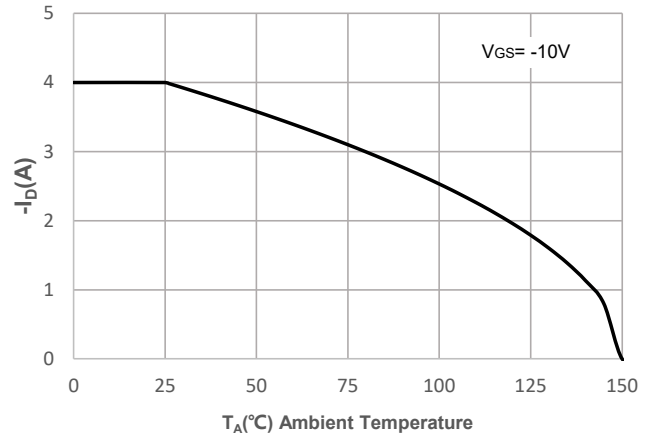

Figure 11: Normalized Maximum Transient Thermal Impedance

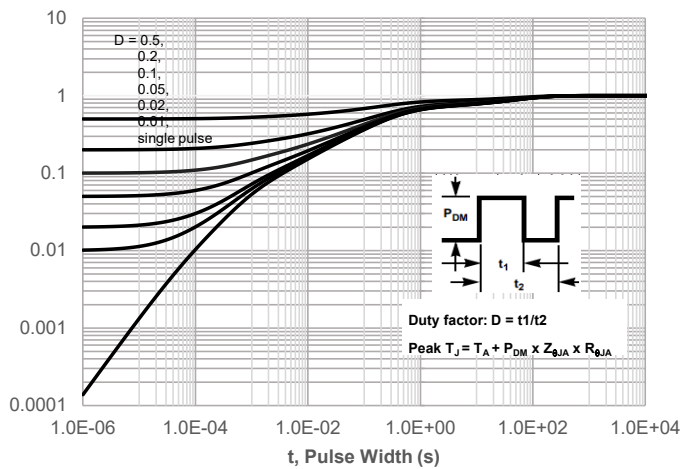
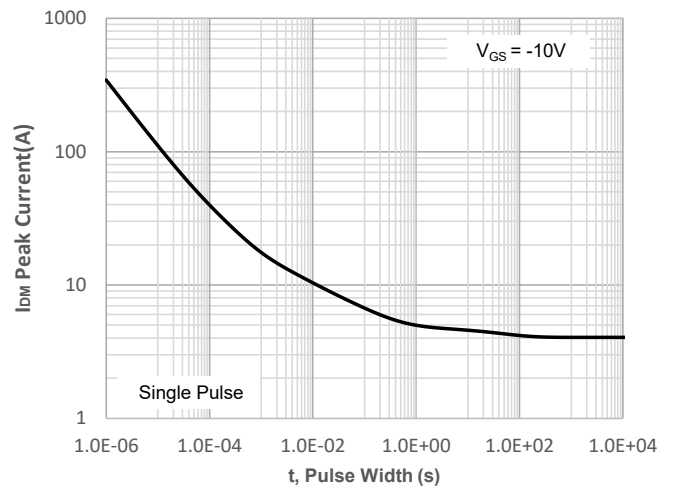

Figure 12: Peak Current Capacity



Test Circuit

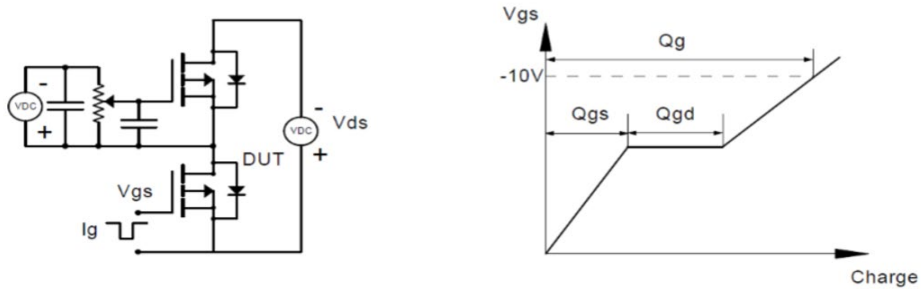

Figure 1: Gate Charge Test Circuit & Waveform

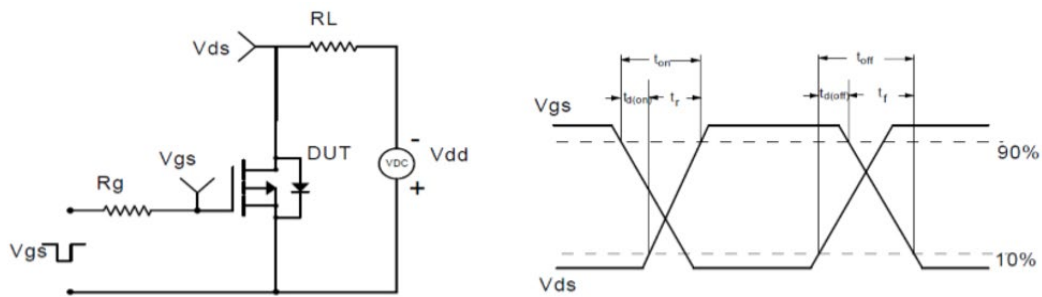

Figure 2: Resistive Switching Test Circuit & Waveform

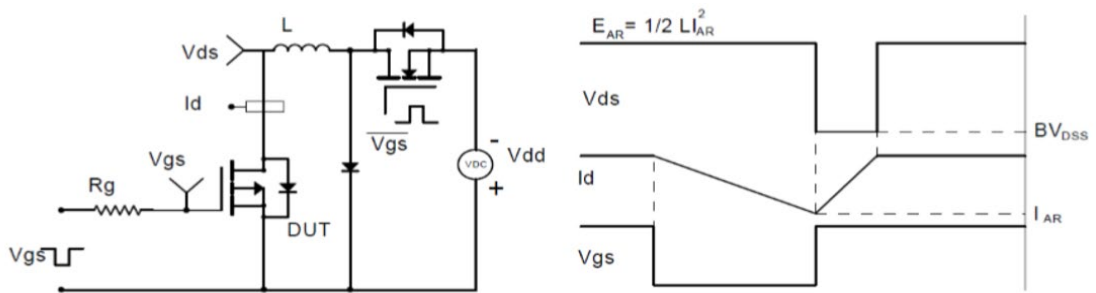

Figure 3: Unclamped Inductive Switching Test Circuit & Waveform

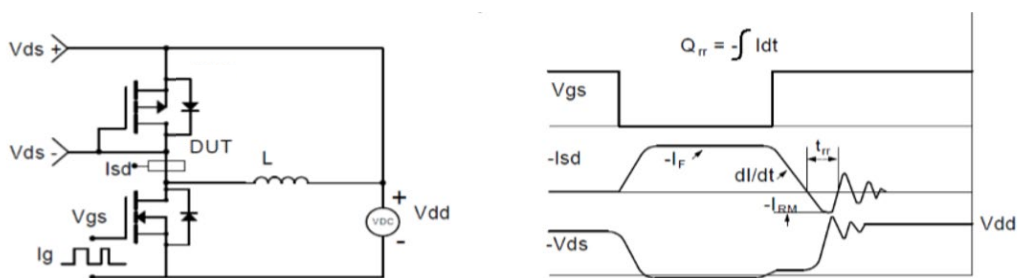
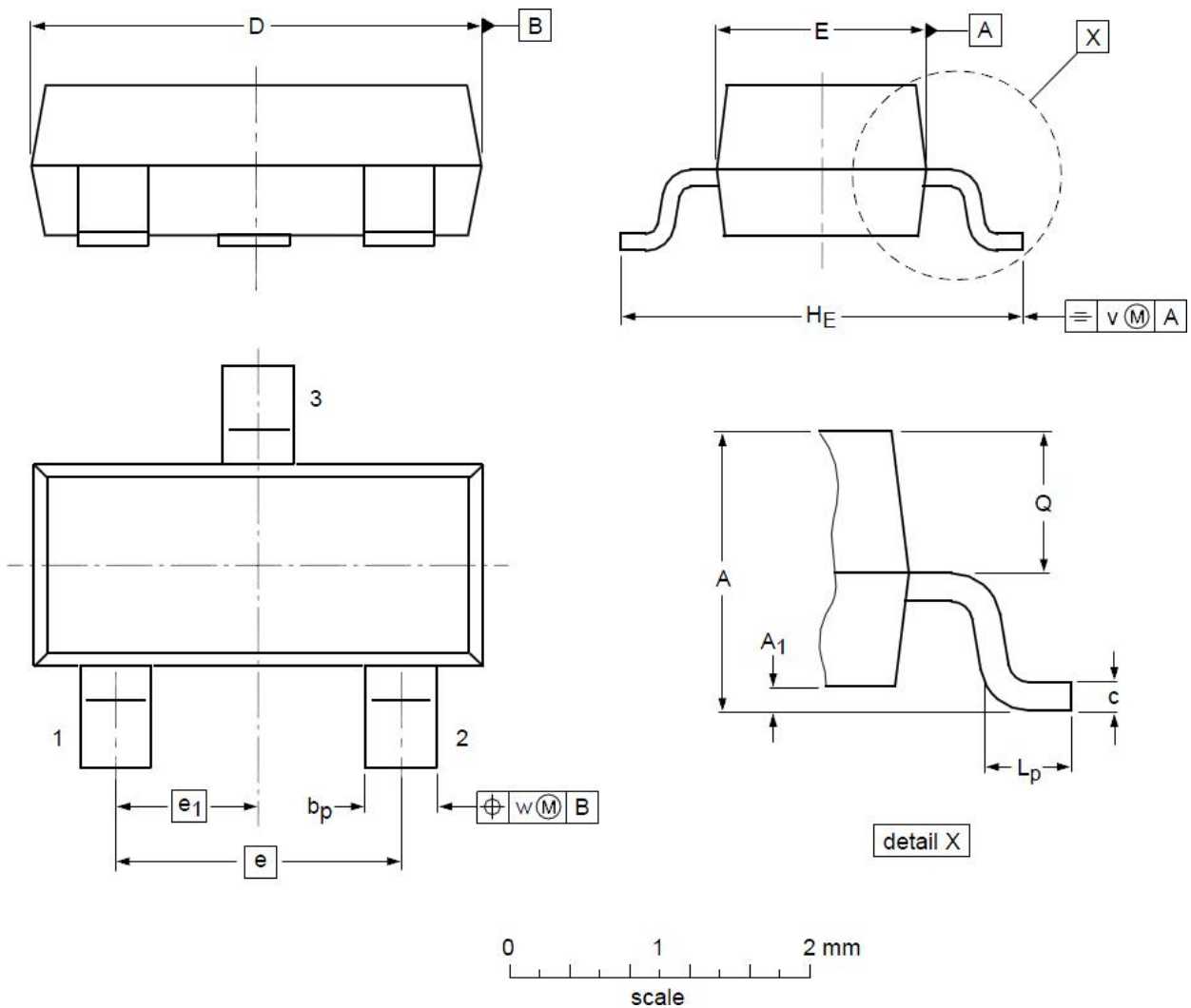

Figure 4: Diode Recovery Test Circuit & Waveform

Package Mechanical Data-SOT-23

DIMENSIONS (unit : mm)

Symbol	Min	Typ	Max	Symbol	Min	Typ	Max
A	0.90	1.01	1.15	A ₁	0.01	0.05	0.10
b _p	0.30	0.42	0.50	c	0.08	0.13	0.15
D	2.80	2.92	3.00	E	1.20	1.33	1.40
e	--	1.90	--	e ₁	--	0.95	--
H _E	2.25	2.40	2.55	L _p	0.30	0.42	0.50
Q	0.45	0.49	0.55	v	--	0.20	--
w	--	0.10	--				