

## 85N06

60V N-Channel MOSFET

### Features:

- Low Intrinsic Capacitances.
- Excellent Switching Characteristics.
- Extended Safe Operating Area.
- Unrivalled Gate Charge : $Q_g = 90\text{ nC}$  (Typ.).
- $V_{DS} = 60\text{V}, I_D = 80\text{A}$
- $R_{DS(on)} : 7\text{m}\Omega$  (Max) @ $V_G = 10\text{V}$
- 100% Avalanche Tested

TO-252

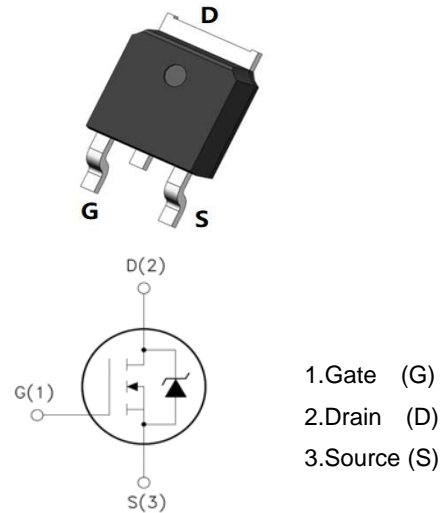

## Absolute Maximum Ratings ( $T_A = 25^\circ\text{C}$ unless otherwise noted)

Symbol	Parameter	Max.	Units
$V_{DS}$	Drain-Source Voltage	60	V
$V_{GS}$	Gate-Source Voltage	$\pm 20$	V
$I_D$	Continuous Drain Current	$T_C = 25^\circ\text{C}$	80
		$T_C = 100^\circ\text{C}$	52
$I_{DM}$	Pulsed Drain Current <sup>note1</sup>	320	A
EAS	Single Pulsed Avalanche Energy <sup>note2</sup>	169	mJ
$P_D$	Power Dissipation	$T_C = 25^\circ\text{C}$	108
$R_{\theta JC}$	Thermal Resistance, Junction to Case	1.4	$^\circ\text{C/W}$
$T_J, T_{STG}$	Operating and Storage Temperature Range	-55 to +175	$^\circ\text{C}$

**Electrical Characteristics** (TA=25°C unless otherwise noted)

Symbol	Parameter	Test Condition	Min.	Typ.	Max.	Units
<b>Off Characteristic</b>						
$V_{(BR)DSS}$	Drain-Source Breakdown Voltage	$V_{GS}=0V, I_D=250\mu A$	60	-	-	V
$I_{DSS}$	Zero Gate Voltage Drain Current	$V_{DS}=60V, V_{GS}=0V,$	-	-	1.0	$\mu A$
$I_{GSS}$	Gate to Body Leakage Current	$V_{DS}=0V, V_{GS}=\pm 20V$	-	-	$\pm 100$	nA
<b>On Characteristics</b>						
$V_{GS(th)}$	Gate Threshold Voltage	$V_{DS}=V_{GS}, I_D=250\mu A$	2	3	4	V
$R_{DS(on)}$	Static Drain-Source on-Resistance <small>note3</small>	$V_{GS}=10V, I_D=30A$	-	5.3	7	m $\Omega$
<b>Dynamic Characteristics</b>						
$C_{iss}$	Input Capacitance	$V_{DS}=30V, V_{GS}=0V,$ $f=1.0MHz$	-	4136	-	pF
$C_{oss}$	Output Capacitance		-	286	-	pF
$C_{rss}$	Reverse Transfer Capacitance		-	257	-	pF
$Q_g$	Total Gate Charge	$V_{DS}=30V, I_D=30A,$ $V_{GS}=10V$	-	90	-	nC
$Q_{gs}$	Gate-Source Charge		-	9	-	nC
$Q_{gd}$	Gate-Drain("Miller") Charge		-	18	-	nC
<b>Switching Characteristics</b>						
$t_{d(on)}$	Turn-on Delay Time	$V_{DS}=30V, I_D=30A,$ $R_G=1.8\Omega, V_{GS}=10V$	-	9	-	ns
$t_r$	Turn-on Rise Time		-	7	-	ns
$t_{d(off)}$	Turn-off Delay Time		-	40	-	ns
$t_f$	Turn-off Fall Time		-	15	-	ns
<b>Drain-Source Diode Characteristics and Maximum Ratings</b>						
$I_S$	Maximum Continuous Drain to Source Diode Forward Current		-	-	80	A
$I_{SM}$	Maximum Pulsed Drain to Source Diode Forward Current		-	-	320	A
$V_{SD}$	Drain to Source Diode Forward Voltage	$V_{GS}=0V, I_S=30A$	-	-	1.2	V
$t_{rr}$	Body Diode Reverse Recovery Time	$I_F=30A, di/dt=100A/\mu s$	-	33	-	ns
$Q_{rr}$	Body Diode Reverse Recovery Charge		-	46	-	nC

Notes:1. Repetitive Rating: Pulse Width Limited by Maximum Junction Temperature

2. EAS condition :  $T_J=25^\circ C, V_{DD}=30V, V_G=10V, L=0.5mH, R_g=25\Omega, I_{AS}=26A$

3. Pulse Test: Pulse Width $\leq 300\mu s$ , Duty Cycle $\leq 0.5\%$

## Typical Characteristics

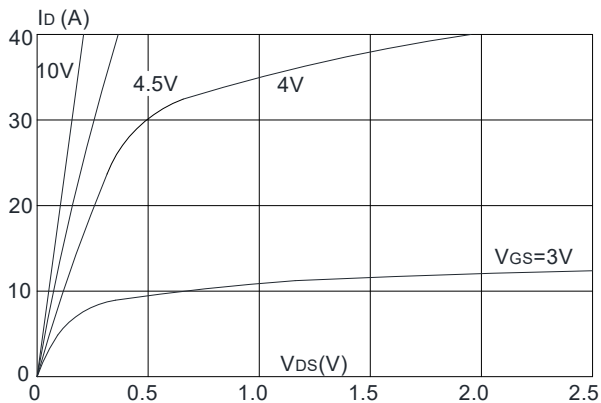
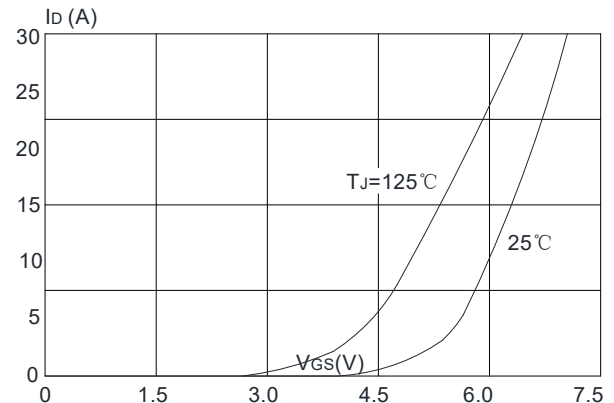
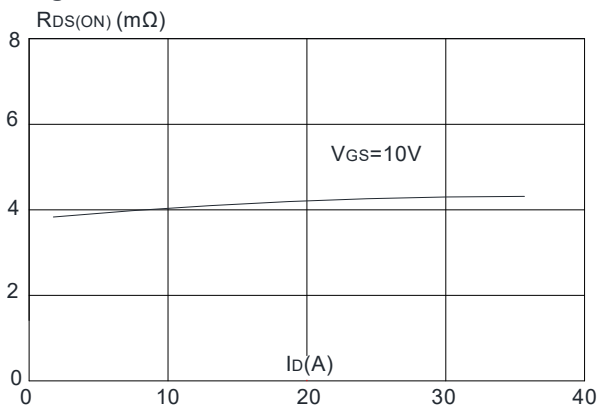
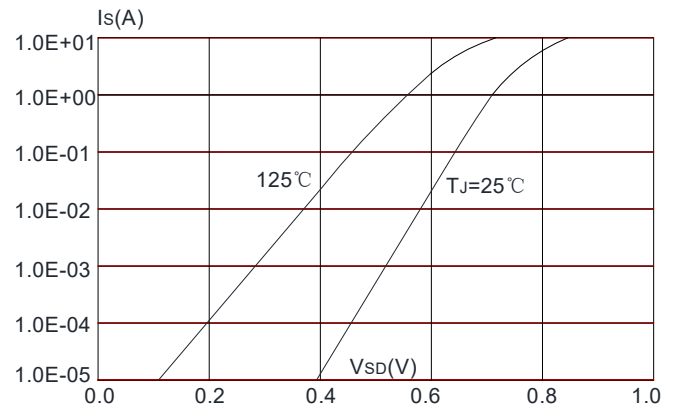
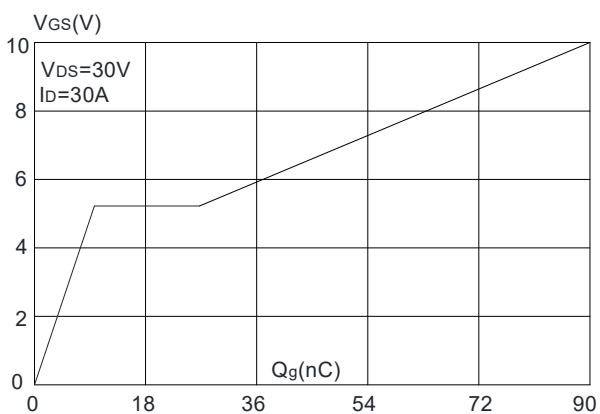
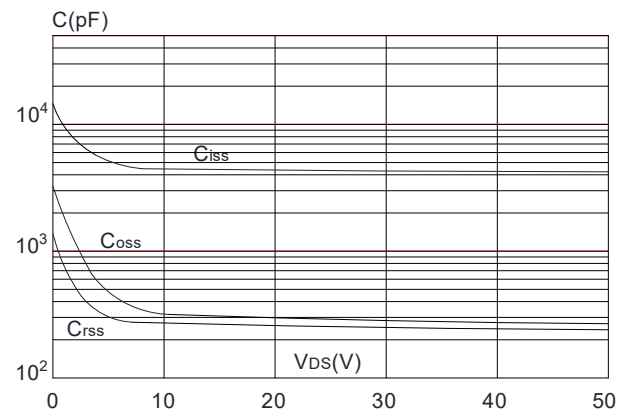
**Figure 1: Output Characteristics**

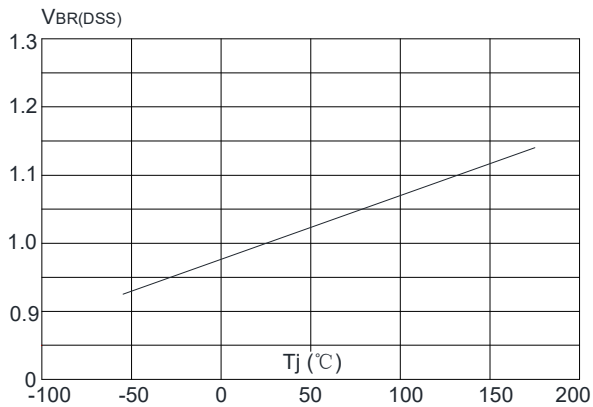
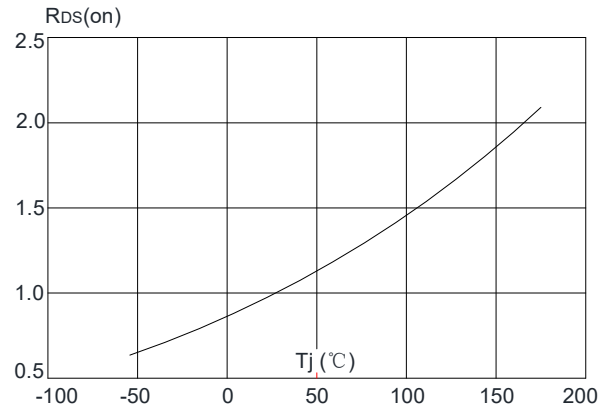
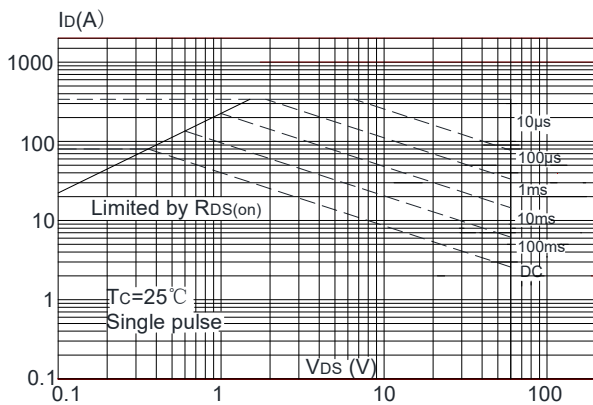
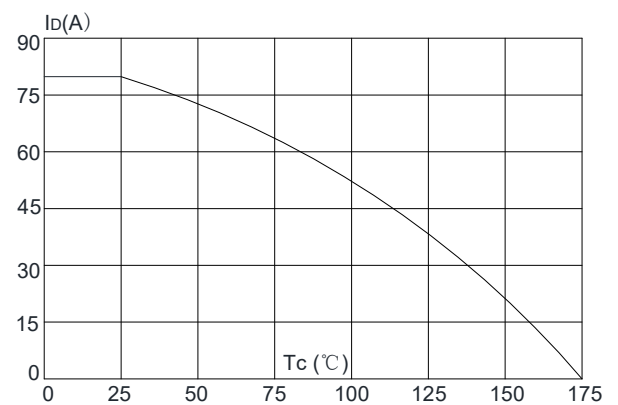
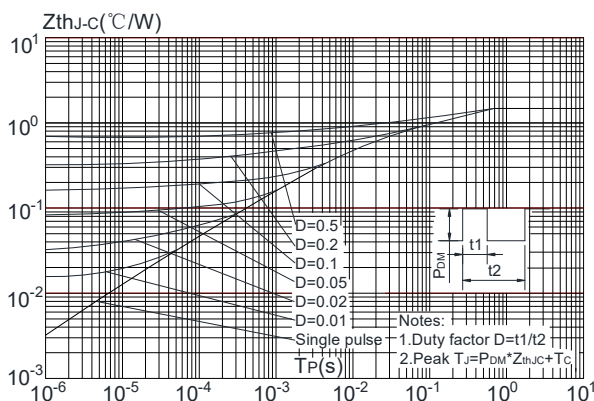
**Figure 2: Typical Transfer Characteristics**

**Figure 3: On-resistance vs. Drain Current**

**Figure 4: Body Diode Characteristics**

**Figure 5: Gate Charge Characteristics**

**Figure 6: Capacitance Characteristics**

**Figure 7: Normalized Breakdown Voltage vs. Junction Temperature**

**Figure 8: Normalized on Resistance vs. Junction Temperature**

**Figure 9: Maximum Safe Operating Area**

**Figure 10: Maximum Continuous Drain Current vs. Case Temperature**

**Figure.11: Maximum Effective Transient Thermal Impedance, Junction-to-Case**

### Test Circuit

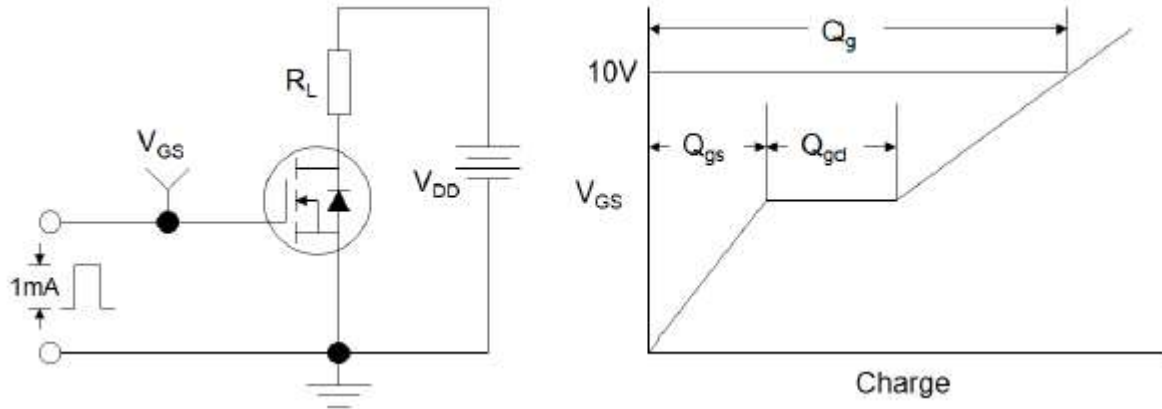

Figure1: Gate Charge Test Circuit & Waveform

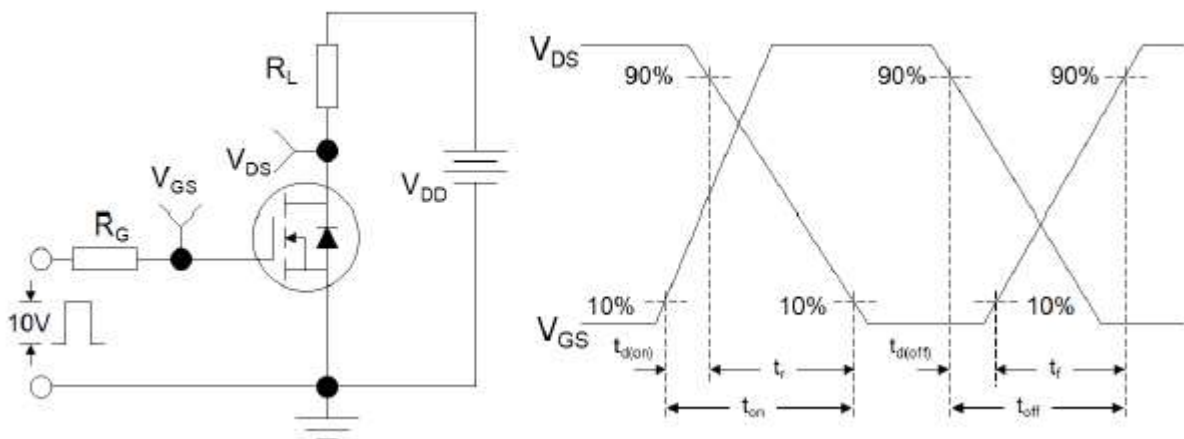

Figure 2: Resistive Switching Test Circuit & Waveforms

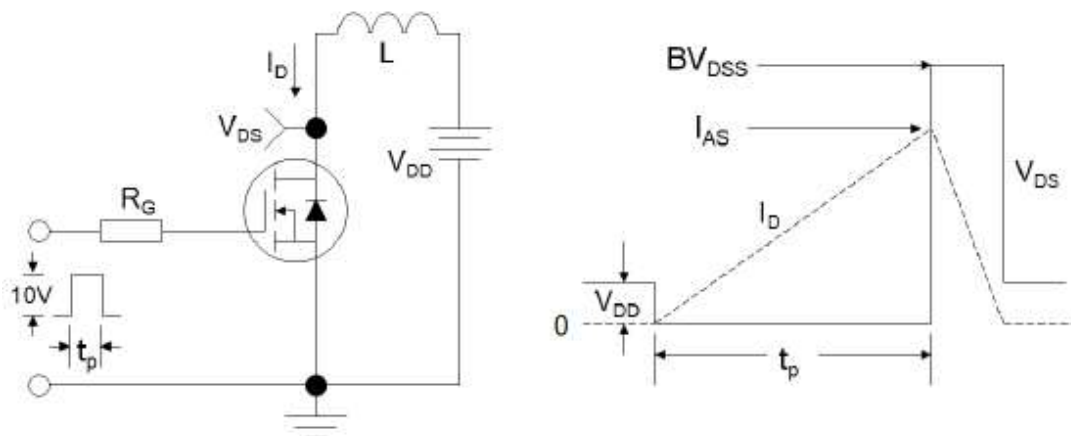
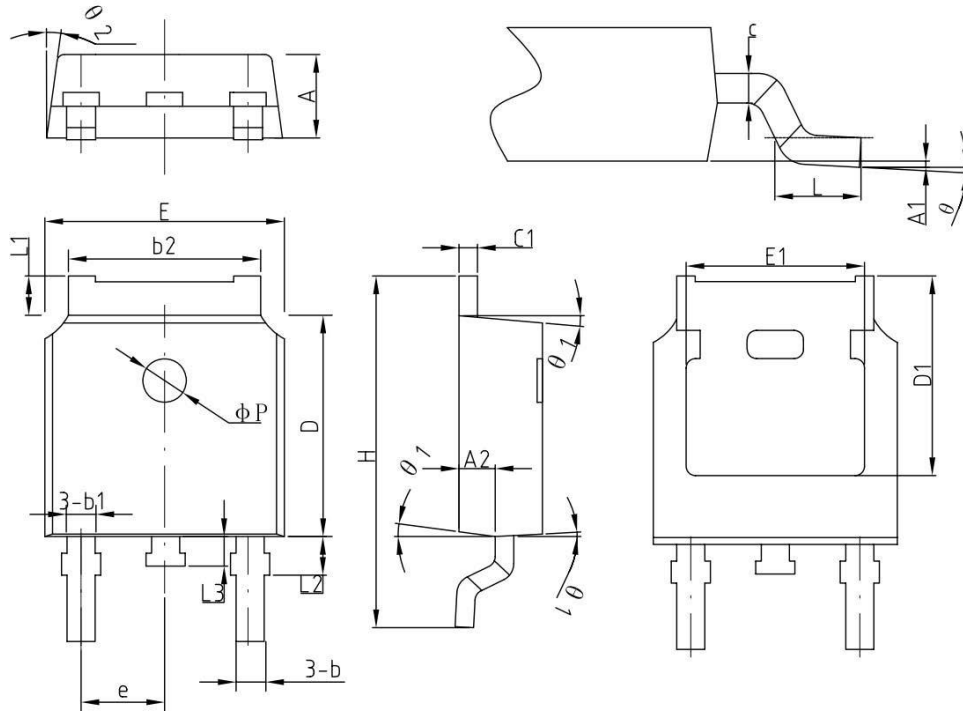

Figure 3: Unclamped Inductive Switching Test Circuit & Waveforms

## Package Dimension

### TO-252

Unit: mm



COMMON DIMENSIONS  
 (UNITS OF MEASURE=MILLIMETER)

SYMBOL	MIN	NOM	MAX
A	2.2	2.30	2.38
A1	0	—	0.10
A2	0.90	1.01	1.10
b	0.71	0.76	0.86
b1		0.76	
b2	5.13	5.33	5.46
c	0.47	0.50	0.60
c1	0.47	0.50	0.60
D	6.0	6.10	6.20
D1	—	5.30	—
E	6.50	6.60	6.70
E1	—	4.80	—
e	2.286BSC		
H	9.70	10.10	10.40
L	1.40	1.50	1.70
L1	0.90	—	1.25
L2		1.05	
L3		0.8	
φP		1.2	
θ	0°	—	8°
θ1	5°	7°	9°
θ2	5°	7°	9°