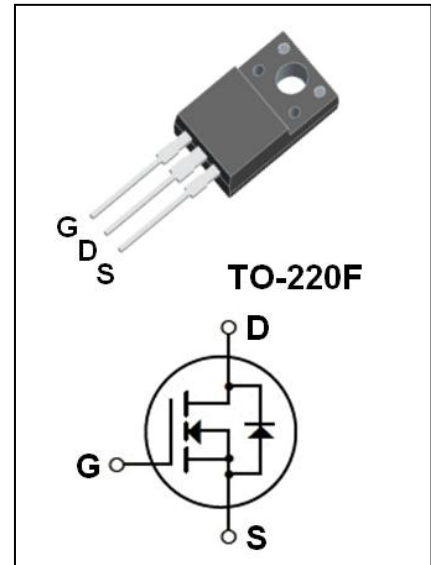

-
- 8.0A, 600V, $R_{DS(on)(Typ)} = 1.0\Omega @ V_{GS}=10V$
- Low Gate Charge
- Low C_{rss}
- 100% Avalanche Tested
- Fast Switching
- Improved dv/dt Capability
- **Application:**
- High Frequency Switching Mode Power Supply
- Active Power Factor Correction

Absolute Maximum Ratings ($T_c=25^\circ\text{C}$ unless otherwise noted)

| Symbol | Parameter | Value | Unit |
|-----------|------------------------------------------------------------------------------------------------------|-------------|---------------------|
| V_{DSS} | Drain-Source Voltage | 600 | V |
| I_D | Drain Current - Continuous ($T_c=25^\circ\text{C}$) - Continuous ($T_c=100^\circ\text{C}$) | 8.0* | A |
| | | 5.1* | A |
| I_{DM} | Drain Current - Pulsed (Note1) | 32* | A |
| V_{GSS} | Gate-Source Voltage | ± 30 | V |
| E_{AS} | Single Pulsed Avalanche Energy (Note2) | 600 | mJ |
| I_{AR} | Avalanche Current (Note1) | 8.0 | A |
| E_{AR} | Repetitive Avalanche Energy (Note1) | 15.0 | mJ |
| dv/dt | Peak Diode Recovery dv/dt (Note3) | 4.5 | V/ns |
| P_D | Power Dissipation ($T_c = 25^\circ\text{C}$) - Derate above 25°C | 51 | W |
| | | 0.41 | W/ $^\circ\text{C}$ |
| T_j | Operating Junction Temperature | 150 | $^\circ\text{C}$ |
| T_{stg} | Storage Temperature Range | -55 to +150 | $^\circ\text{C}$ |

* Drain Current Limited by Maximum Junction Temperature.

Thermal Characteristics

| Symbol | Parameter | Max | Unit |
|-----------------|-----------------------------------------|------|-----------------------------|
| $R_{\theta JC}$ | Thermal Resistance, Junction to Case | 2.44 | $^\circ\text{C} / \text{W}$ |
| $R_{\theta JA}$ | Thermal Resistance, Junction to Ambient | 62.5 | $^\circ\text{C} / \text{W}$ |

Electrical Characteristics(Tc=25°C unless otherwise noted)

| Symbol | Parameter | Test Conditons | Min | Typ | Max | Unit |
|---------------------------------------------------------------|-------------------------------------------------------|-------------------------------------------------------------------------------------|-----|------|------|------|
| Off Characteristics | | | | | | |
| BV _{DSS} | Drain-source Breakdown Voltage | V _{GS} =0V, I _D =250μA | 600 | -- | -- | V |
| ΔBV _{DSS} /ΔT _J | Breakdown Voltage Temperature Coefficient | I _D =250μA (Referenced to 25°C) | -- | 0.7 | -- | V/°C |
| I _{DSS} | Zero Gate Voltage Drain Current | V _{DS} =600V, V _{GS} =0V | -- | -- | 1 | μA |
| | | V _{DS} =480V, Tc=125°C | -- | -- | 10 | μA |
| I _{GSSF} | Gate-Body Leakage Current, Forward | V _{GS} =+30V, V _{DS} =0V | -- | -- | 100 | nA |
| I _{GSSR} | Gate-Body Leakage Current, Reverse | V _{GS} =-30V, V _{DS} =0V | -- | -- | -100 | nA |
| On Characteristics | | | | | | |
| V _{GS(th)} | Gate Threshold Voltage | V _{DS} = V _{GS} , I _D =250μA | 2.0 | -- | 4.0 | V |
| R _{DS(on)} | Static Drain-Source On-Resistance | V _{GS} =10 V, I _D =4.0A | -- | 1.0 | 1.2 | Ω |
| g _{FS} | Forward Transconductance | V _{DS} =40 V, I _D =4.0A (Note4) | -- | 7 | -- | S |
| Dynamic Characteristics | | | | | | |
| C _{iss} | Input Capacitance | V _{DS} =25V, V _{GS} =0V, f=1.0MHz | -- | 1400 | -- | pF |
| C _{oss} | Output Capacitance | | -- | 175 | -- | pF |
| C _{rss} | Reverse Transfer Capacitance | | -- | 16 | -- | pF |
| Switching Characteristics | | | | | | |
| t _{d(on)} | Turn-On Delay Time | V _{DD} = 300 V, I _D = 8.0 A, R _G = 25 Ω (Note4,5) | -- | 13.5 | -- | ns |
| t _r | Turn-On Rise Time | | -- | 105 | -- | ns |
| t _{d(off)} | Turn-Off Delay Time | | -- | 128 | -- | ns |
| t _f | Turn-Off Fall Time | | -- | 49 | -- | ns |
| Q _g | Total Gate Charge | V _{DS} = 480 V, I _D =8.0 A, V _{GS} = 10 V (Note4,5) | -- | 31 | -- | nC |
| Q _{gs} | Gate-Source Charge | | -- | 6.5 | -- | nC |
| Q _{gd} | Gate-Drain Charge | | -- | 14.7 | -- | nC |
| Drain-Source Diode Characteristics and Maximum Ratings | | | | | | |
| I _S | Maximum Continuous Drain-Source Diode Forward Current | | -- | -- | 8.0 | A |
| I _{SM} | Maximum Pulsed Drain-Source Diode Forward Current | | -- | -- | 32 | A |
| V _{SD} | Drain-Source Diode Forward Voltage | V _{GS} =0V, I _S =8.0A | -- | -- | 1.4 | V |
| t _{rr} | Reverse Recovery Time | V _{GS} =0V, I _S =8.0A, d I _F /dt=100A/μs (Note4) | -- | 325 | -- | ns |
| Q _{rr} | Reverse Recovery Charge | | -- | 2.7 | -- | μC |

Notes:

- 1、Repetitive Rating:Pulse Width Limited by Maximum Junction Temperature.
- 2、L = 18.5mH, I_{AS} =8.0A, V_{DD} = 50V, R_G = 25 Ω, Starting T_J = 25°C.
- 3、I_{SD}≤8.0A, di/dt≤200A/μs, V_{DD}≤BV_{DSS}, Starting T_J = 25°C.
- 4、Pulse Test : Pulse Width ≤300 μ s, Duty Cycle≤2%.
- 5、Essentially Independent of Operating Temperature.

On-Regin Characteristics

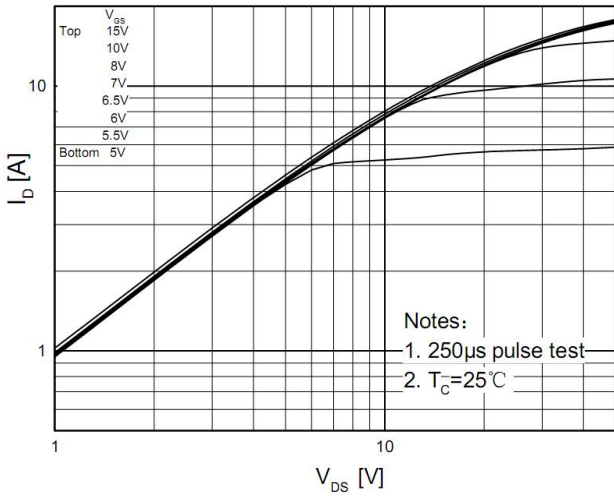

Transfer Characteristics

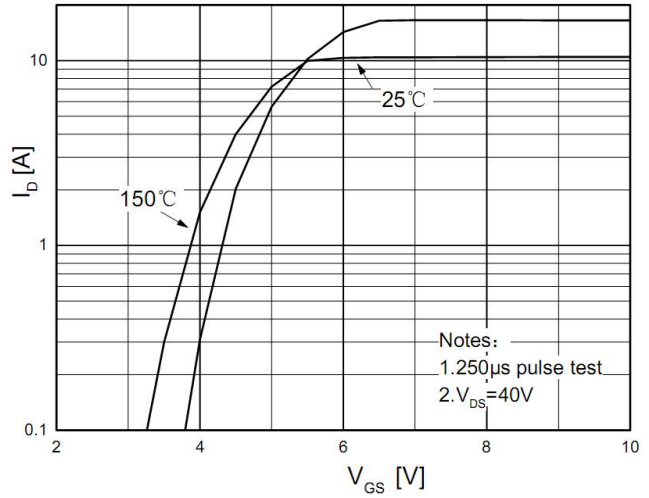

On-Resistance Variation vs. Drain Current and Gate Voltage

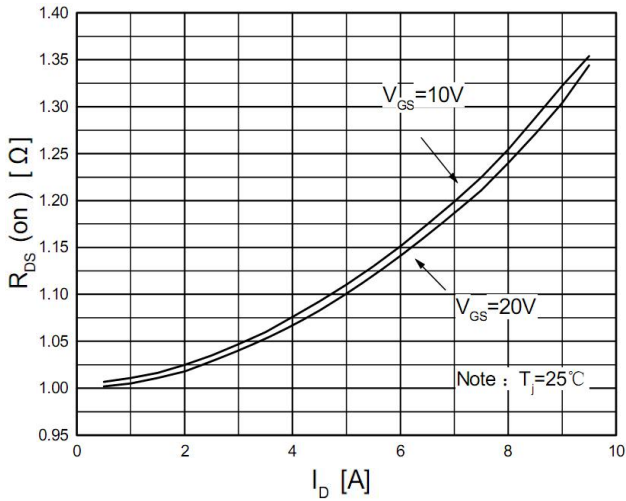

Body Diode Forward Voltage Variation vs. Source Current and Temperature

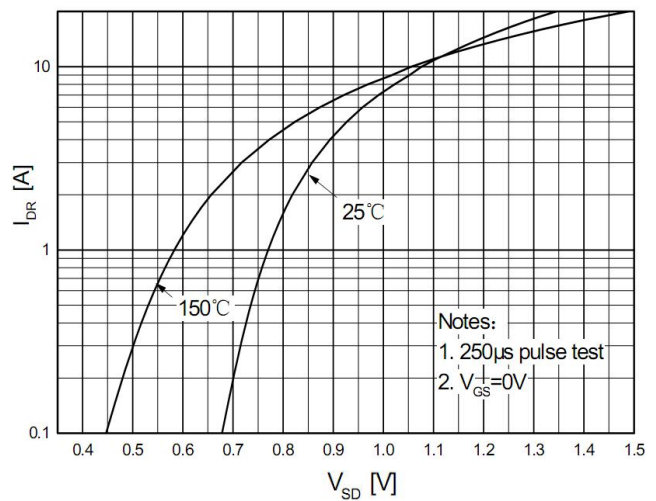

Capacitance Characteristics

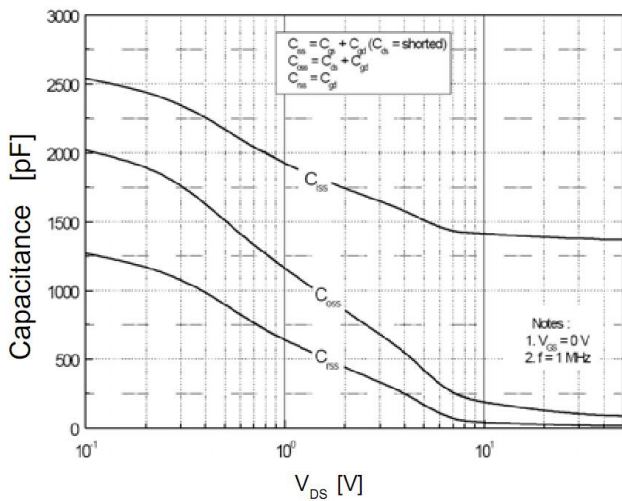

Gate Charge Characteristics

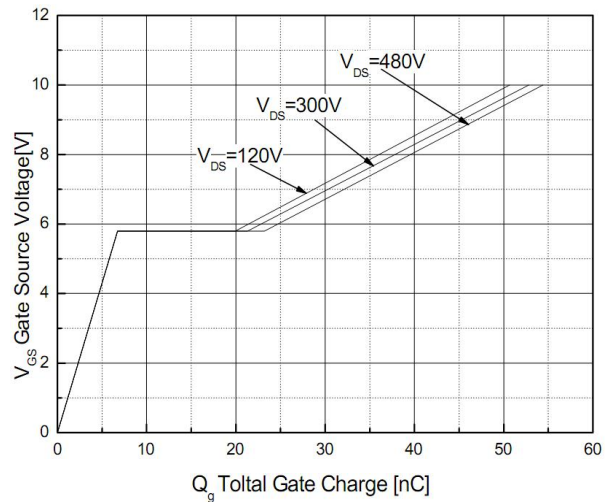

Breakdown Voltage Variation vs. Temperature

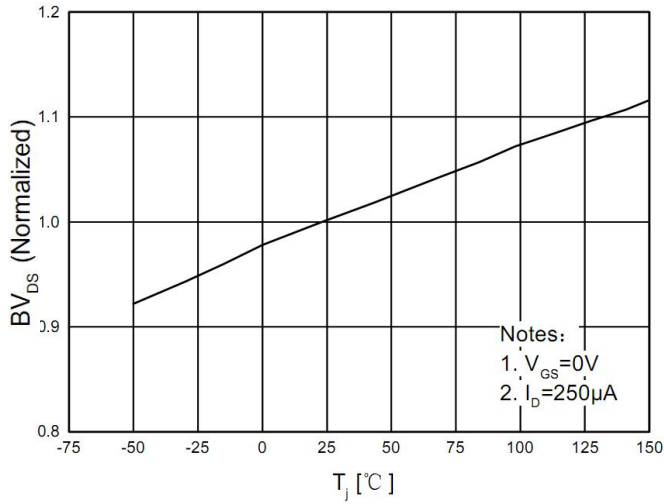

On-Resistance Variation vs. Temperature

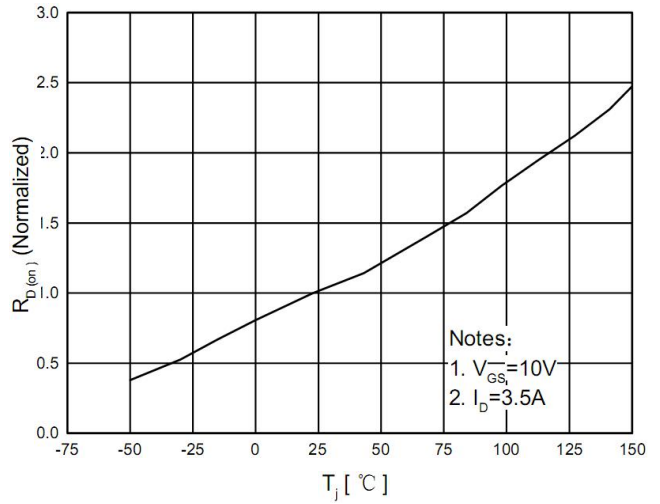

Maximum Safe Operating Area

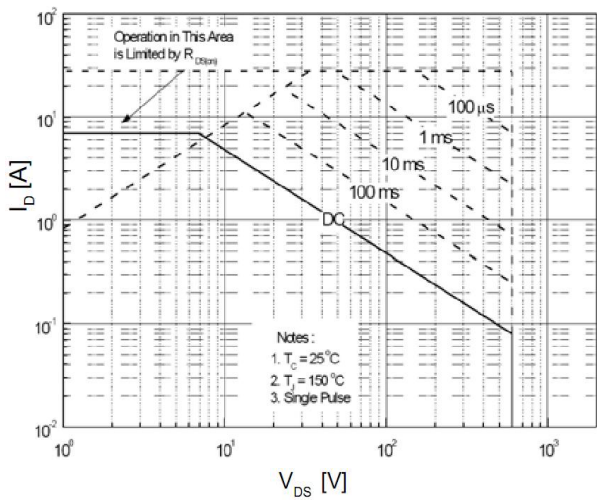

Maximum Drain Current Vs. Case Temperature

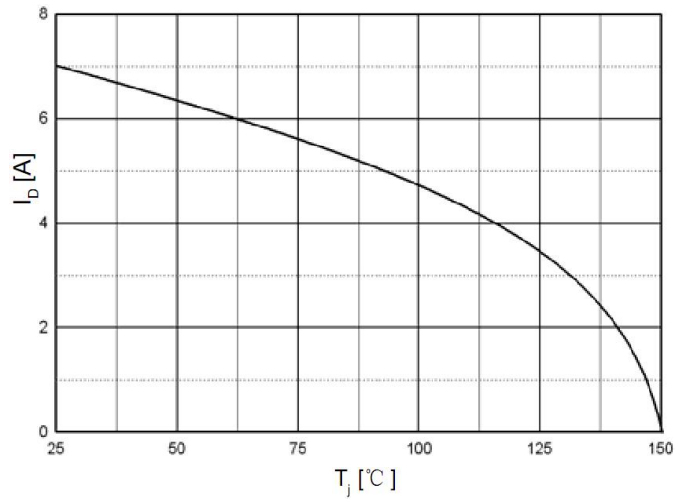

TO-220F Package Dimensions

UNIT: mm

| SYMBOL | min | nom | max | SYMBOL | min | nom | max |
|--------|-------|------|-------|--------|------|---------|------|
| A | 9.80 | | 10.60 | D | | 2.54 | |
| A1 | | 7.00 | | D1 | 1.15 | | 1.55 |
| A2 | 2.90 | | 3.40 | D2 | 0.60 | | 1.00 |
| A3 | 9.10 | | 9.90 | D3 | 0.20 | | 0.50 |
| B1 | 15.40 | | 16.40 | E | 2.24 | | 2.84 |
| B2 | 4.35 | | 4.95 | E1 | | 0.70 | |
| B3 | 6.00 | | 7.40 | E2 | | 1.0×45° | |
| C | 3.00 | | 3.70 | E3 | 0.35 | | 0.65 |
| C1 | 15.00 | | 17.00 | E4 | 2.30 | | 3.30 |
| C2 | 8.80 | | 10.80 | α (度) | | 30° | |

