

PNP Transistors

2SB1189

■ Features

- High breakdown voltage, $V_{CE0}=-80V$, and High Current, $I_c=-0.7A$
- Complementary to 2SD1767

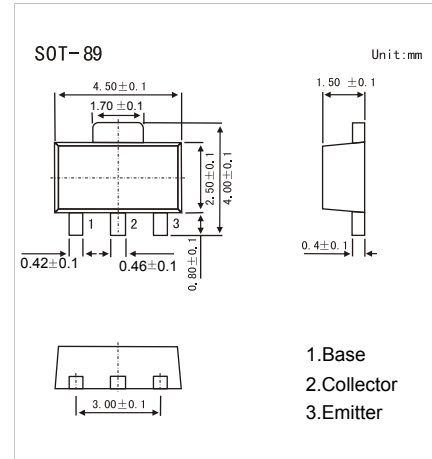

■ Absolute Maximum Ratings $T_a = 25^{\circ}C$

Parameter	Symbol	Rating	Unit
Collector - Base Voltage	V_{CBO}	-80	V
Collector - Emitter Voltage	V_{CEO}	-80	
Emitter - Base Voltage	V_{EBO}	-5	
Collector Current - Continuous	I_c	-0.7	A
Collector Power Dissipation	P_c	0.5	W
		2	
Junction Temperature	T_J	150	$^{\circ}C$
Storage Temperature range	T_{stg}	-55 to 150	

■ Electrical Characteristics $T_a = 25^{\circ}C$

Parameter	Symbol	Test Conditions	Min	Typ	Max	Unit
Collector- base breakdown voltage	V_{CBO}	$I_c = -100 \mu A, I_E = 0$	-80			V
Collector- emitter breakdown voltage	V_{CEO}	$I_c = -2 mA, I_B = 0$	-80			
Emitter - base breakdown voltage	V_{EBO}	$I_E = -100 \mu A, I_C = 0$	-5			
Collector-base cut-off current	I_{CBO}	$V_{CB} = -60V, I_E = 0$			-0.5	μA
Emitter cut-off current	I_{EBO}	$V_{EB} = -4V, I_C = 0$			-0.5	
Collector-emitter saturation voltage	$V_{CE(sat)}$	$I_C = -500 mA, I_B = -50mA$		-0.2	-0.4	V
Base - emitter saturation voltage	$V_{BE(sat)}$	$I_C = -500 mA, I_B = -50mA$			-1.2	
DC current gain	h_{FE}	$V_{CE} = -3V, I_C = -100 mA$	120		390	
Collector output capacitance	C_{ob}	$V_{CB} = -10V, I_E = 0, f = 1MHz$		14	20	pF
Transition frequency	f_T	$V_{CE} = -5V, I_E = 50mA, f = 100MHz$		100		MHz

■ Classification of h_{fe}

Type	2SB1189-Q	2SB1189-R
Range	120-270	180-390
Marking	BD Q*	BD R*

PNP Transistors

2SB1189

■ Typical Characteristics

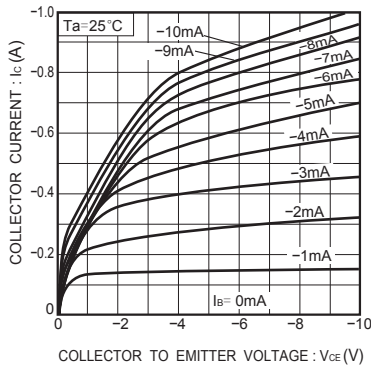

Fig.1 Ground emitter output characteristics

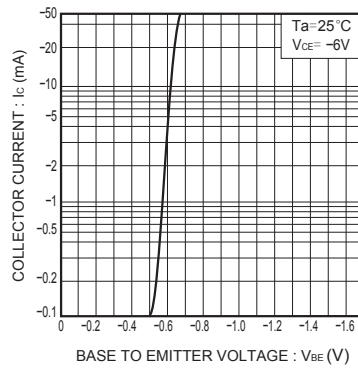

Fig.2 Ground emitter propagation characteristics

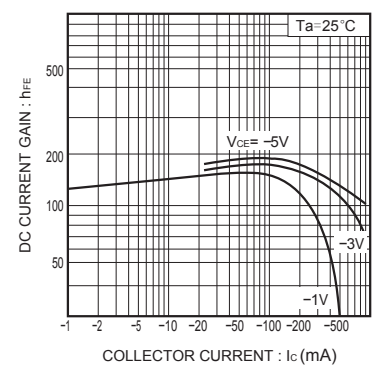

Fig.3 DC current gain vs. collector current

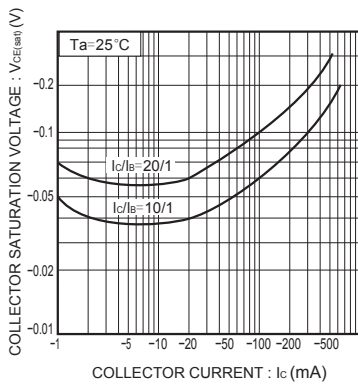

Fig.4 Collector-emitter saturation voltage vs. collector current

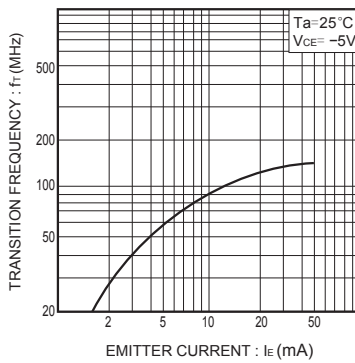

Fig.5 Gain bandwidth product vs. emitter current

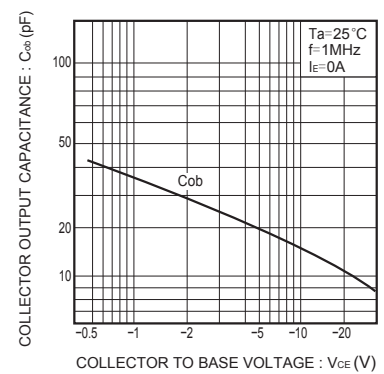

Fig.6 Collector output capacitance vs. collector-base voltage

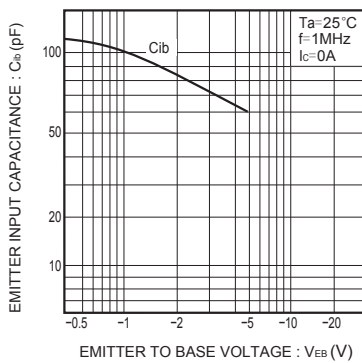

Fig.7 Emitter input capacitance vs. emitter-base voltage

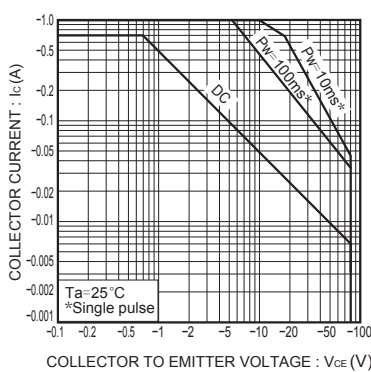

Fig.8 Safe operating area (2SB1189)